



Figure 1: Heathkit IP-5220 Variable Isolated AC Supply

Heathkit of the Month #113:
by Bob Eckweiler, AF6C



ELECTRONIC TEST EQUIPMENT

Heathkit IP-5220 Variable Isolated AC Supply.

Introduction:

If you work on anything that plugs into an AC outlet and are going to take the covers off, it is a good idea to use an isolation transformer to protect yourself from becoming an accidental conductor to ground. With that in mind Heathkit, back in 1953, introduced the IT-1 Isolation Transformer¹ which can handle 100 volt-ampere (VA)² continuously or up to 200 VA intermittently. It also allows adjustment of the output voltage from about 90 to 130 VAC which can be read on an inexpensive voltmeter on the front panel. The IT-1 sold for \$16.50 and weighs 7½ lbs. Heathkit replaced the IT-1 with the IP-10 (circa 1960 - 1962) and IP-22 (circa 1962 - 1964). They both sold originally for \$54.95 and weighed about 18 lbs. The IP-22 is mostly a styling change from the IP-10 as the two

circuits are close if not identical. They will be briefly discussed later in the article. From 1965 until 1975 Heathkit did not produce an AC isolation transformer kit.

The IP-5220 Variable Isolated AC Supply:

Heathkit introduced the IP-5220 (Figure 1), its next (and last) AC isolation supply, in the Christmas 1975 catalog #806³ with a ⅓ page announcement (See Figure 2). The introductory price was \$109.95, and it weighs 22 lbs. The supply sold for eight years until mid-1983. In the winter 1983 catalog #860 it was selling for \$154.95. Late in 1981 Heathkit introduced a factory-built version designated the SP-5220, priced at \$190.00. At that time the IP-5220 was selling for \$144.95.

IP-5220 Front Panel Layout:

On the front panel there are two AC outlets. The one to the farthest right is wired directly to the AC input line, and is not isolated, nor is it fused or switched by the front panel

Here is a link to the index of Heathkit of the Month (HotM) articles:

http://www.w6ze.org/Heathkit/Heathkit_Index.html

1. Notes begin on page 9

The Heath family of high-value supplies -with a new variable AC supply

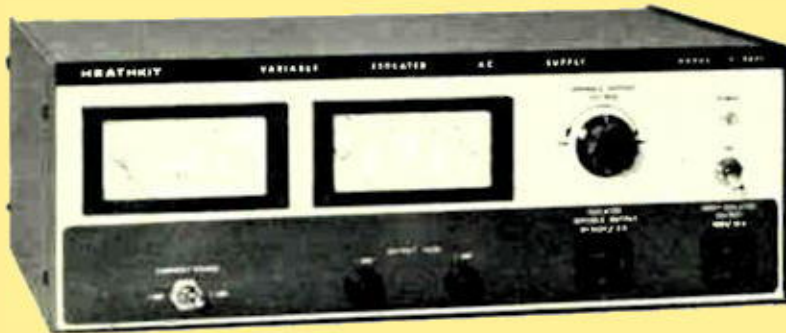

New Heathkit IP-5220 Variable Isolated AC Supply

- Safe isolated source of AC power for service work
- Variable 0-140 VAC output
- 1 A & 3 A ammeter ranges for easy low-current readings
- Simultaneous metering of voltage and current output

Every service tech and hobbyist needs a Heathkit IP-5220. With this new variable AC source, you can isolate transformerless equipment for safer operation when servicing. It provides complete isolation between the AC power line and any electrical equipment that is plugged into its front panel variable output socket. The variable 0-140 volt output is useful anywhere a slow run-up of line voltage is needed...like the initial turn-on of that new breadboard you've been building. A full 360 volt-amperes of AC power — available at the front panel variable output socket. More than enough to operate equipment with large power requirements, such as a color TV. And the IP-5220 is capable of supplying its full rated output continuously. The IP-5220's ability to start from zero voltage is helpful when trying to locate circuit faults caused by high or low line voltage — or testing equipment with unknown power requirements. You simply monitor the

output on the large voltmeter and ammeter as output voltage is increased. When excessive current is observed, power can be quickly and easily removed before components are damaged. For easier low current measurements, the ammeter has two switch-selected full scale ranges of 1 A and 3 A. Fuses for both ranges are front panel mounted for easy replacement. The variable output socket is fused to protect the IP-5220 and the circuit under test in case of a short circuit. A socket for direct line connection is front panel mounted for convenience.

Kit IP-5220, 27 lbs., available 109.95

IP-5220 SPECIFICATIONS — Input Voltage: 120 V @ 60 Hz for specified output. Output Voltage: 0-140 V @ 60 Hz. Voltmeter Range: 0-150 VAC. Ammeter Ranges: 0-1 & 0-3 A, AC. Output Current: 3 A max, 10 A (direct line connection). Output Power: 360 Volt-Ampere maximum. Dimensions: 5.5" H x 15" W x 10.5" D.

Figure 2: 1975 Ad introducing the Heathkit IP-5220 Variable Isolated AC Supply

POWER switch which sits above the outlet. When the **POWER** switch is in the **ON** position a yellow neon pilot light above it is illuminated. This outlet is rated for 120 VAC 10 amps maximum and is marked: **NON-ISOLATED-OUTPUT 120 VAC / 10A**. To the left of this outlet is a second AC outlet marked: **ISOLATED VARIABLE OUTPUT 0 – 140 VAC / 3A**. Above this outlet is the knob for the **VARIABLE OUTPUT VOLTAGE** transformer (T1). An arrow marked **MIN** at full CCW and **MAX** at full CW shows knob rotation.

To the left of the second outlet are two adjacent **OUTPUT FUSE** holders. The one to the left is marked **1 AMP** and the one to the right is marked **3 AMPS**. Above the fuse holders is a meter that measures the variable output voltage. It has a scale that reads **0 to 150 AC VOLTS** with numbers every 30 volts, major tick marks every 10 volts and minor tick marks every 2 volts. **Figure 3** shows the meter scales. To the left of the **OUTPUT FUSE** holders is a toggle switch marked **CURRENT RANGE**

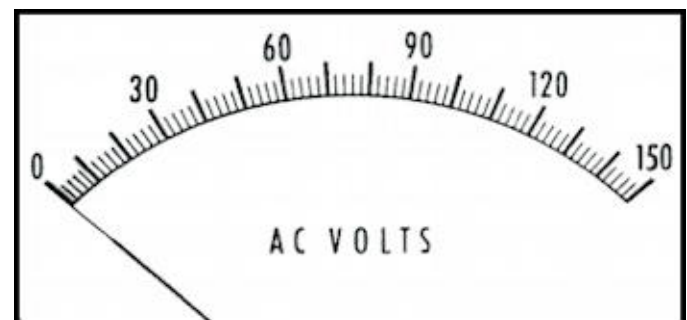
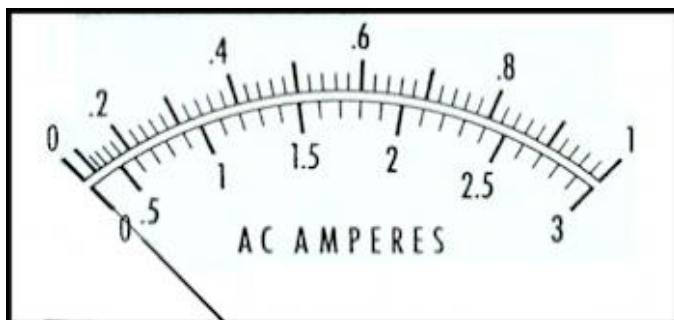

Figure 3: The IP-5220 Ammeter and Voltmeter Scales

with the left position marked **1 AMP** and the right position marked **3 AMPS**. Above the toggle switch is a meter that measure the isolated output current. The meter has two scales: **0-1** and **0-3 AC AMPERES**. The 0-1 ampere scale is numbered every 0.2 amperes with major tic marks every 0.1 amperes and minor tic marks every 0.02 amperes starting after the 0.1 major tic mark. The 0-3 ampere scale is numbered and has a major tic mark every 0.5 ampere with minor tic marks every 0.1 ampere starting after the 0.5 major tic mark. Due to the internal rectifiers the ammeter scales are not linear at their low end.

IP-5220 Features and Specifications:

One feature of the IP-5220, not available on the earlier units, is a voltage range that extends all the way down to zero and up to 140 VAC; prior Heathkit isolation transformers only output 90 to 130 VAC. Another feature added is the ammeter. Earlier isolation transformers have only one meter that measures voltage only. On the IP-10 and IP-22 it may be switched between reading the input (line) voltage or the output (isolation) voltage. On the IT-1 and IP-5220 only the output voltage is read. The IT-1 meter is non-linear and undamped, and the user has to let the meter come to rest before reading.

The IP-5220 power output is specified for each of its two current ranges. On the 1-amp range the maximum power you can draw is set by the 1-amp fuse. That is 140 VA at 140 VAC. For this range, the allowable VA at other voltages is the same as the voltage setting. On the 3-amp range, up to 120 volts you are limited to 3-amperes by the fuse, the allowed VA is equivalent to 3 times the voltage. But above 120 volts the maximum of 360 VA is reached so the current maximum begins to drop. At 140 volts the maximum current is limited to under 2.6 amps⁴. The

published specifications are shown in **Table I**. **Graph I** shows the allowed maximum current for the given voltage for each of the two selectable current ranges.

IP-5220 Operation:

The IP-5220 provides a AC voltage source that the user can control to test equipment under conditions of high and low line voltage. It also provides protection by isolating both sides of the AC line from ground reference.

Prior to plugging in a device under test (DUT) the IP-5220 should be turned on and set to the desired voltage for the test to be performed. Next, the current range should be selected depending on the current draw of the DUT. With the DUT powered off it can

Specifications for the Heathkit IP-5220 Variable Isolated AC Supply: From Heath Manual I-595-1773	
Input Voltage:	120 VAC 60 Hz for specified output
Output Voltage:	0 – 140 VAC 60 Hz
Voltmeter Range: (Accuracy:	0 – 150 VAC full scale not specified)
Ammeter Ranges:	0 – 1 and 0 – 3 Amperes AC, (accuracy not specified)
Output Current:	3 Amperes maximum 10 Amperes (direct line connector).
Output Power:	360 Volt-amperes maximum in three ampere range 140 Volt-Amperes maximum in 1 ampere range.
Net Weight:	22 lbs.
Overall Dimensions:	15" W x 10½" D x 5½" H (38 cm x 27 cm x 14 cm)

TABLE I

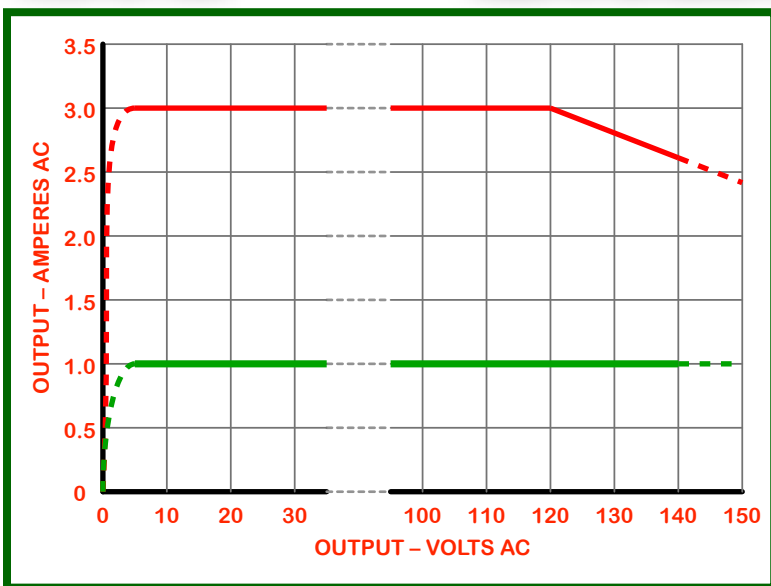

Graph I: Allowed output current vs. output voltage for the 1-ampere (green) and 3-ampere (red) ranges.

then be plugged into the ISOLATED outlet (be sure to use the correct outlet).

Now the device can be powered on and testing begun. If searching for an intermittent, operation at line voltages above and below nominal can be done by adjusting the voltage control.

If you are going to slowly bring up a DUT that has been sitting idle for a long period, start at a near zero voltage and monitor for excessive current that may indicate a short or badly leaking filter capacitor. One word of caution. Many vacuum tubes that use a filament instead of a heater⁵ have a coated filament. Some coated filaments can be easily damaged by running the filament at lower than specified voltage. One tube that is easily damaged in this way is the 1V2 HV rectifier used in many older Heathkit oscilloscopes and the HO-10 and HO-13 monitor scopes. Many rectifiers such as the 5Y3, 5V4, and 5U4 also use coated filaments but are less prone to damage. High Power transmitter tubes such as the 572B and 3-500Z use easily damaged thoriated tungsten filaments

and have tight specs on their filament voltage.

IP-5220 Circuit:

The IP-5220 circuit is shown in **Figure 6** on **page 16**. The AC line is directly connected to the 10-amp convenience outlet (S2) and may be used as needed for a soldering iron, piece of test equipment or such. The AC line is also connected to T1, a variable autotransformer⁶ (**Figure 4**) through an internal 7-amp slow-blow fuse (F1) and the POWER switch (SW1). The autotransformer has a single tap (terminal 4) about 90.9% of the way from the cold end (terminal 1). A rotary wiper (terminal 3) can tap any winding from the cold end to the winding top (terminal 2).

With 120 input, T1's output can be varied from 0 to 132 VAC. The autotransformer offers no isolation; that is accomplished by T2, a 3-ampere isolation transformer which has a slight voltage step up ratio of 16:15 so 120 volts in yields 128 volts out. Thus, at max voltage the output will be just under 141 VAC.

Output from T2 is fed through ammeter M1 to the CURRENT RANGE switch (SW2) which selects one of two fuses: 1-ampere (F2) or 3-ampere (F3) depending on the range selected. SW2 also switches in a current shunt across M1 when in the 3-ampere range. M1 is a 1-ampere full-scale ammeter with a coil resistance of 0.287Ω. To increase the current capability of the meter to 3-amperes, it needs to be shunted by a resistance of 0.144Ω. This shunt is provided by R1, a coil of resistance wire on a phenolic cylinder (**Figure 5**). The full winding is specified to be 0.2Ω. A tap is connected to the windings to provide the proper shunt resistance during calibration. The output of the two fuses (F2 and F3) are fed to the 150 VAC voltmeter (M1) which is

in parallel with the isolated variable output outlet (S1).

IP-5220 Calibration:

The only calibration needed for the IP-5220 is making the resistance tap connection on the shunt resistor R1. During construction of the

kit, the wire from switch SW2 (terminal 2) is terminated with a test probe such as one used on a voltmeter. Also, before R1 is mounted, a ¼-inch wide strip of the resistor varnish insulation is sanded off along the coil to allow probing and soldering. After check out is completed a load is applied to the isolated output (S1). The suggested load is an incandescent 150 watt light bulb or parallel bulbs that draw 150 or more watts (Good luck finding one at your local hardware store today!) With the VARIABLE OUTPUT VOLTAGE control fully counterclockwise, and the CURRENT RANGE switch in the 3 AMP position, turn the POWER switch ON. Slowly advance the VARIABLE OUTPUT VOLTAGE control until the ammeter (M1) reads 3A full scale (Without the shunt you are really only measuring 1 ampere.) Now, using the test probe wired to SW2, slowly move it on the bare area along the length of the resistor coil until the ammeter (M1) reads 1-ampere on the 3-ampere scale. While holding the probe at this point unplug the unit and carefully place a piece of tape on the turn just to its right (away from the unconnected end). Remove the probe from the wire end, and without shortening the lead solder it to the exposed turn next to the tape. It's okay if the solder shorts some the turns away from the tape as they are not used. Finally plug the unit back in and check that the meter still reads 1-am-



Figure 4: A variable autotransformer similar to T1 that is used in the IP-5220. This is a Powerstat 10B made by the Superior Electric Company.

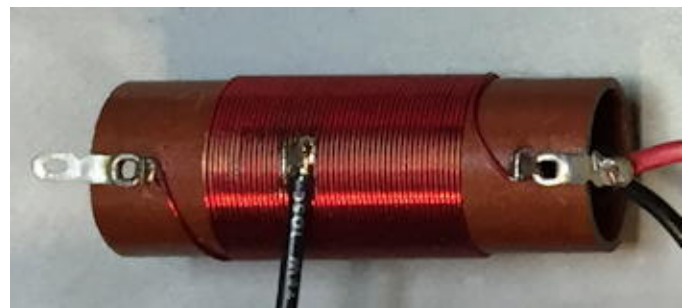

Figure 5: R1 The ammeter shunt resistor. During calibration the tap location on the resistance coil is determined and the wire soldered on.

pere on the 3-ampere scale. That completes calibration.

IP-5220 Assembly:

Assembly of the IP-5220 is very straightforward. The Heathkit manual I-595-1773 is only 20 pages excluding covers, replacement parts order form and some blank “note” pages. Actual assembly is covered in about eight pages, including the Final Assembly section done after completing checkout and calibration.

Most of the wiring uses black #18 gauge wire (7½’ is provided) so you may want to use a heavier soldering iron than normally used for kit building. Some connections are done with push-on connectors; though the connector still has to be soldered to its wire.

Assembly begins with the installation of the feet on the chassis, then most of the chassis and front panel mounted parts, followed by wiring and the addition of the heavy isolation transformer. The chassis is then put aside and the meters are mounted to the meter bracket.

The variable autotransformer is unpacked next and mounted; its shaft bushing helps hold the meter bracket to the chassis. Then a few final solder connections are made, and lead dress is checked, especial-

Figure 6: Schematic of the IP-5220 Variable Isolated AC Supply. T1 is the variable auto transformer and T2 is the isolation transformer.

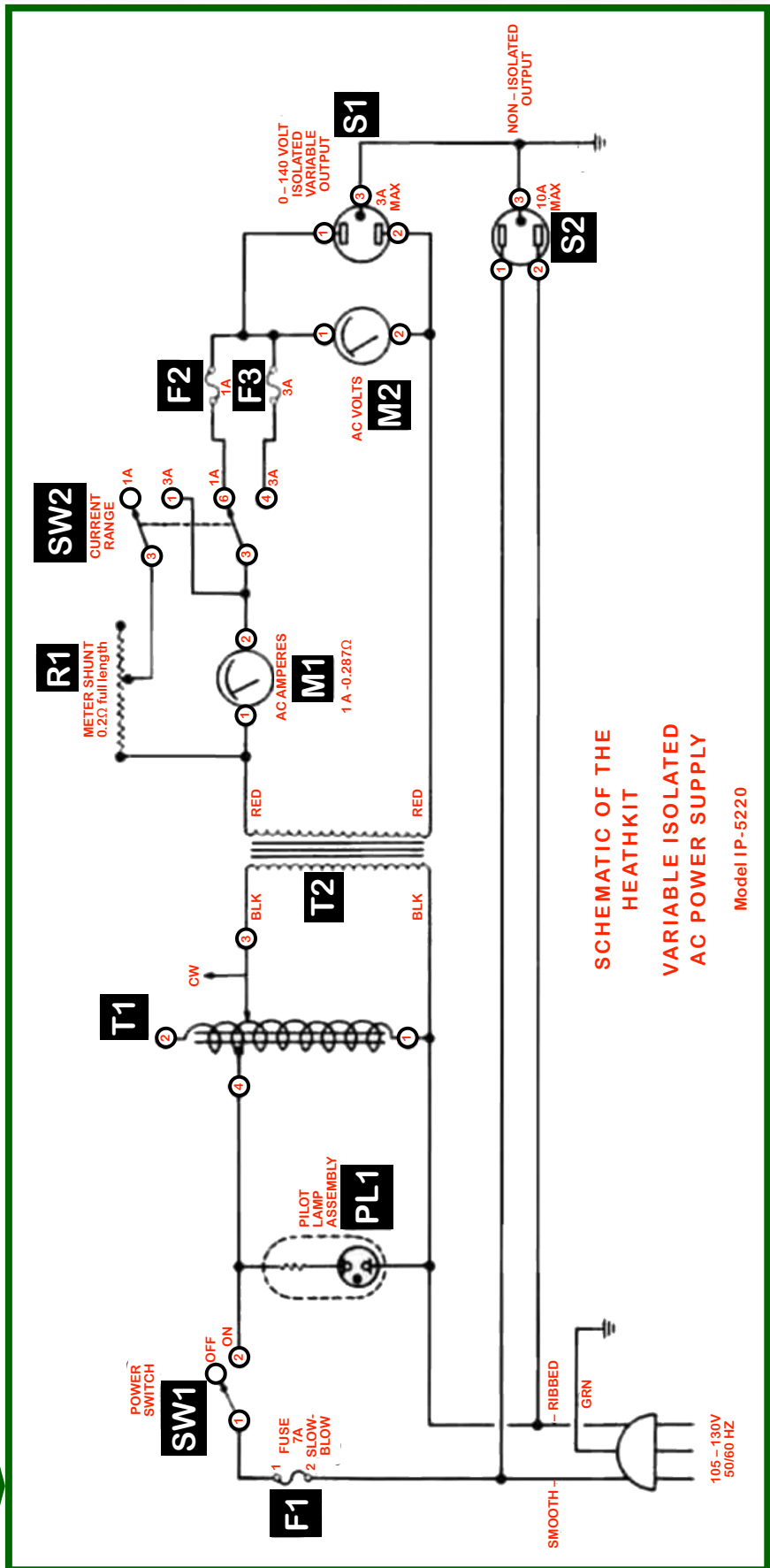

**SCHEMATIC OF THE
HEATHKIT
VARIABLE ISOLATED
AC POWER SUPPLY**
Model IP-5220

ly around T1, that can get extremely hot during operation at higher currents.

Final assembly involves adding the side panels, top cover, blue and white label containing the part and series numbers, and the model label that mounts in the trim bar along the top of the front panel.

Comments on Heat and T1:

To quote the last assembly instruction prior to test and calibration:

() *Position all wires away from transformer T1, as T1 will get hot during operation and could melt the insulation from nearby wires and possibly cause a short circuit.*

It’s interesting to note that the wire supplied with the kit is rated at 105°C. On one website there is a photo of the inside of an IP-5220 that shows where the neighboring voltmeter’s plastic case has suffered major heat damage⁷. Evidently the meter still works just fine.



Figure 7: T1 is believed to be made by Staco Power Products of Dayton, Ohio. Note when the input terminals 1 & 4 are used, the output is 132 V, not 140 V. Also note that using terminals 1 & 4 the transformer may not be used at 50 Hz.

This high heat makes one wonder if T1 is running above the manufacturer’s ratings. The Powerstat 10B (**Figure 4**) appears to be close to T1 in size and is rated conservatively at 2.25 amps and 297 VA. **Figure 7** is a partial photo of T1 transformer from the web. Note that though the IP-5220 is rated for 0 to 140 volts, the output of the variable transformer only goes to 132 volts. The additional 8 volts is developed in T2, If anyone has their IP-5200 open and can get the current and VA rating of the T1 transformer I’d be interested in what they find.

Heathkit IP-10 and IP-22:

Between the 1953 IT-1 and the 1975 IP-5220 Heathkit sold the IP-10 and IP-22 isolation transformers. Unfortunately the IP-10 manual is not available to the author at this time. There is a schematic available on the web titled: “Schematic of the Heathkit Isolation Transformer Model IP-10/IP-22”. So for now the assumption is the schematics are identical.

Unlike the IT-1 and IP-5220, these isolation transformers don’t use a variable transformer. Instead they use a transformer with a multi-tap secondary. One end of the transformer has a 5.25 volt winding that is tapped every 0.75 volts. The central winding is 90 volts with no taps, and the top winding is 36.75 volts with taps every 5.25 volts. The total secondary is 132 volts. There are two eight-position rotary switches; one (S1) OUTPUT VOLTAGE COARSE selects one of the eight taps on the 36.75 volt winding, and the other (S2) OUTPUT VOLTAGE FINE selects one of the eight taps on the 5.25 volt winding. Thus the user may select any voltage from 90 to 132 VAC in 56 steps of 0.75 volts each.

A second feature of the IP-10 / IP-22 is the expanded voltmeter that has a scale that reads from 90 to 140 VAC. The meter may be

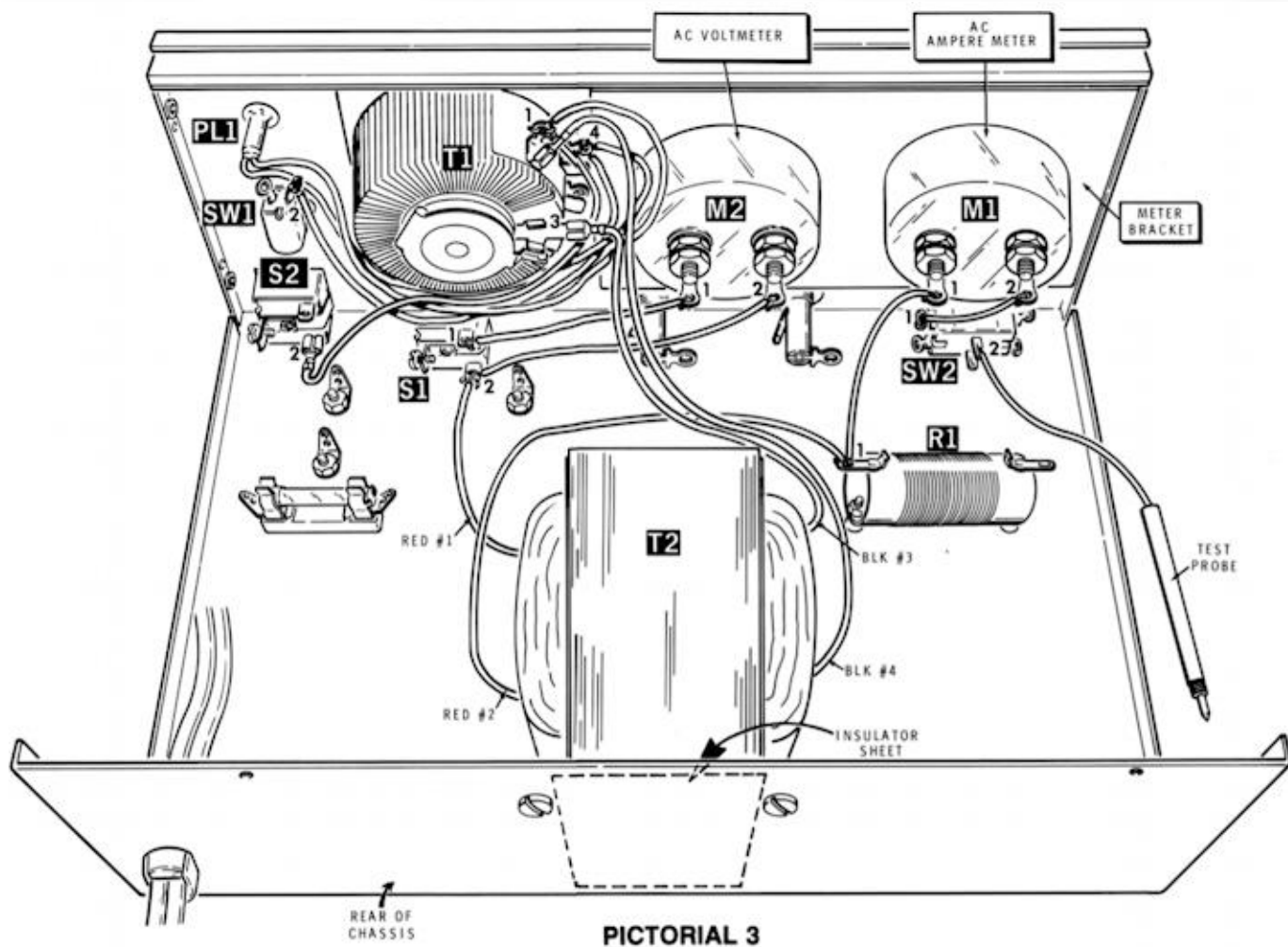

Figure 8: (Pictorial 3 from the manual) shows the inside layout of the IP-5220 during assembly. Note on the right the test probe on the end of the wire from SW2. This probe is used to find the “sweet spot” on R1 during calibration and is then removed and relegated to one’s junk box.

switched to measure either the input line voltage or the isolated output voltage. The expanded scale capability is achieved by a bridge circuit and a 0C3 voltage regulator vacuum tube that sets the offset voltage. The meter accuracy is specified as ± 1 V.

The IP-10 / IP-22 has two parallel isolated outlets. The third (ground) terminal of the two outlets connects to a front panel binding post. It is next to a ground binding post. Thus the user can isolate or ground the third contact on the isolated outlets or connect it to some other point or potential.

Final Comments:

I started to write this article on the IP-2715 Battery Eliminator which shares a lot of components with the HP-1144(A) power supplies for the SB-104(A) transceivers. I had obtained the IP-2715 late last year, and a brief checkout showed it was in working order and worth an article.

However, I couldn’t find a manual online and bought one through Don Peterson of the new Heathkit; they sell vintage manuals – Excellent service and reasonable prices. There is a glitch on their website that sometimes caus-

es the international shipping price to appear when you put in a US location. It happened to me and to others. Changing browsers sometimes cures the problem. I do have to say that I once placed an order with the wrong postage showing, and noticed the price was corrected when I finished the order. Since Don is in California, the Governor takes his cut in sales taxes. These manuals are usually clean, spiral bound copies with a "Heathkit" cover on them. I believe in owning a "paper" manual for any Heathkit I own.

The manual came in just a couple of days but I was already making good progress on the IP-5220 article since that manual was on-hand. Look for the IP-2715 article soon. The manual I received is a late one, (595-1845-06) and has changes not found in earlier units.

73, from AF6C



Notes:

1. See HotM #18: Heathkit IT-1 Isolation Transformer. https://www.w6ze.org/Heathkit/Heathkit_018_IT1.pdf
2. In AC theory Volt-amperes (VA) differs from Watts. VA is the RMS voltage times the RMS current. Watts is the VA times the cosine of the phase difference between V and A.
3. The IP-5220 may have also appeared in an earlier catalog, unavailable to the author.
4. Actually 2.57143 for the person who wrote and complained that I round off my calculations too severely.
5. The term filament is used when the heating element is also the cathode. Heater is used when the heating element and cathode are separate. The 6X4 has a heater, the 5Y3 has a filament.
6. These autotransformers are often referred to by their brand names Variac® or Powerstat®.
7. https://www.byan-roper.org/steve/Media/img_0520.jpeg.

Remember if you are getting rid of any old Heathkit Manuals or Catalogs, please pass them along to me for my research.

This article is copyright 2022, and originally appeared in the September issue of 'RF', the newsletter of the Orange County Amateur Radio Club - W6ZE.

Thanks - AF6C

HEATHKIT ISOLATION TRANSFORMER COMPARISON CHART

FEATURE	IT-1	IP-10 / IP-22	IP-5220
INPUT VOLTAGE	117 VAC 50/60 cycles	105-125 VAC 50/60 cycles	120 VAC 60 Hz
ISOLATED OUTPUT VOLTAGE	90 - 130 VAC (continuous)	90 - 130 VAC (0.75 V Steps)	0 - 140 VAC (continuous)
POWER RATING - Continuous	100 VA	300 VA	140 VA (in 1-amp range) 360 VA (in 3-amp range)
POWER RATING - Intermittent	200 VA	500 VA	(same as continuous)
VOLTMETER	50 - 150 VAC (undamped) Output Voltage Only	90 - 140 VAC (Expanded scale) Input or Output Voltage (switched)	0 - 150 VAC Output Voltage Only
AMMETER	(none)	(none)	DUAL: 0 - 1 AMP / 0 - 3 AMP
ISOLATED OUTLET(S)	1 ea. 2-wire (Non Polarized)	2 ea. 3-wire (Polarized)	1 ea. 3-wire (Polarized)
UNISOLATED (CONVENIENCE) OUTLET	(none)	(none)	1 ea. 3-wire
NET WEIGHT	7 Lbs 8 oz (measured)	18 Lbs (manual)	22 Lbs (manual)